

[TopPage](#)>>[Search Result](#)>>7304CDF

Angular Contact Ball Bearings

Bearing No. : **NACHI 7304CDF**

■ Bearing Type

■ Clearance

■ Tolerance Class

Dimensions

d = 20⁰_{-0.010}
 D = 52⁰_{-0.013}
 B = 15⁰_{0.000}
 r = 1.1~2
 (Radial Direction)
 r = 1.1~3.5
 (Axial Direction)
 r1 = 0.6~1
 (Radial Direction)
 r1 = 0.6~2
 (Axial Direction)
 a = -3.2

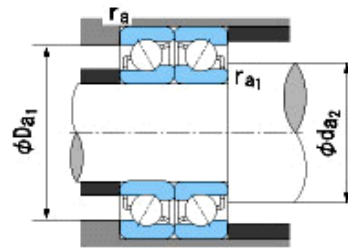
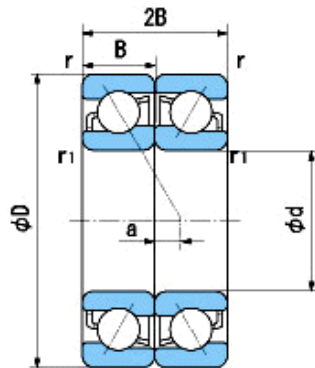

Dimensions
 da1(min) = 27
 da2(min) = 27
 Da1(max) = 45
 Da2(max) = 47
 ra(max) = 1
 ra1(max) = 0.6
 Mass = 0.3 kg

Basic Dynamic Load Rating Cr : **30,000** N
 Basic Static Load Rating Cor : **20,000** N
 Limiting Speed ;
 Grease Lubrication : **18,000** min⁻¹
 Oil Lubrication : **25,000** min⁻¹

	INNER RING	OUTER RING
O.D.Surface Runout with Side :		-
Axial Runout with Bore :	-	-
Axial Runout with Raceway :	-	-
Width Variation :	0.020	0.020
Radial Runout :	0.013	0.025